

- Ⓐ Colector drenaje 2"
2" Drainage manifold
- Ⓑ Colector entrada 16"
16" Inlet manifold
- Ⓒ Colector salida 16"
16" Outlet manifold

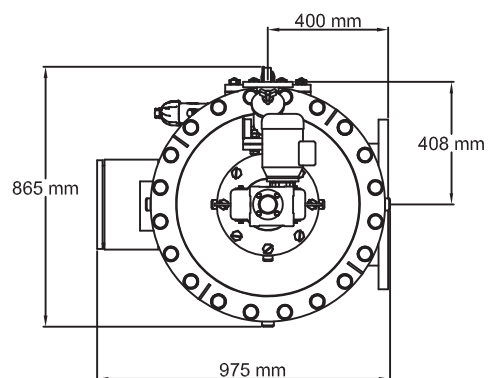

AZUD LUXON LDB 20100/16

SCALE S/E A4 FORMAT	MATERIAL:	RESPONS.: M. Martínez	AZUD
	UNITS: mm.	REVISION: 00	
	FILE: Azud_luxon_LDB_20100-16.dwg	08/05/2012	